

Product overview

Batteries for Marine and Leisure

Vintage EU140-6



Part number	EU140-6
Technology	Flooded
EAN/GTIN	3661024036153
Voltage	6 V
Capacity	140 Ah
CCA	900 A
Length	257 mm
Width	175 mm
Height	236 mm
Box size	M04
Polarity	ETN 0
Terminal Type	EN taper post
Hold Down	B1
Weights (subject of variation)	18.40 kg

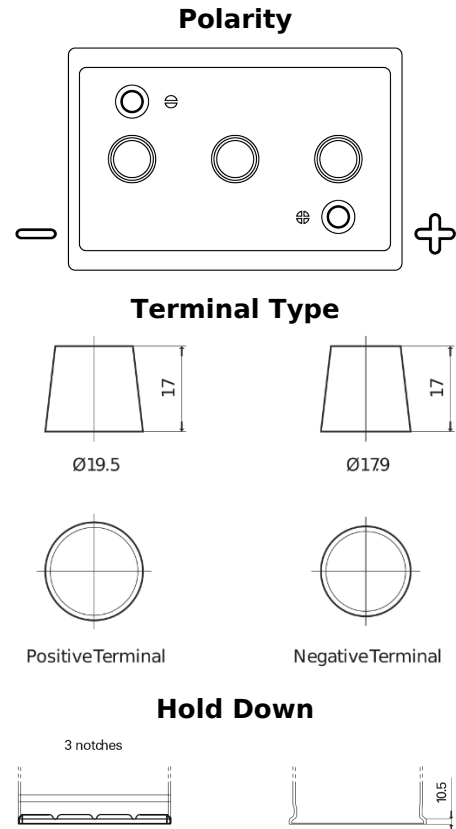

Design, features and specifications are subject to change without notice. We disclaim any representation or warranty, express or implied, concerning the data or recommendations, and in no event shall be liable for any loss or damage claimed to have arisen as a result. Some products may not be available in your local market.