

Product overview

Batteries for Motorcycles, ATVs, Snowmobiles, Garden

Conventional EB10L-B



Part number	EB10L-B
Technology	Flooded
EAN/GTIN	3661024033350
Voltage	12 V
Capacity	11.0 Ah
CCA	130 A
Length	135 mm
Width	90 mm
Height	145 mm
Box size	C47
Polarity	ETN 0
Terminal Type	M06
Hold Down	B0
Weights (subject of variation)	4.10 kg

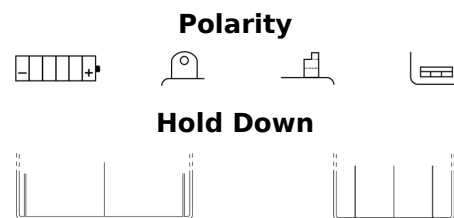

Design, features and specifications are subject to change without notice. We disclaim any representation or warranty, express or implied, concerning the data or recommendations, and in no event shall be liable for any loss or damage claimed to have arisen as a result. Some products may not be available in your local market.