

Product overview

Batteries for Cars

Standard FC652



| | |
|--------------------------------|---------------|
| Part number | FC652 |
| Technology | Flooded |
| EAN/GTIN | 3661024044868 |
| Voltage | 12 V |
| Capacity | 65 Ah |
| CCA | 540 A |
| Length | 278 mm |
| Width | 175 mm |
| Height | 175 mm |
| Box size | LB3 |
| Polarity | ETN 0 |
| Terminal Type | EN taper post |
| Hold Down | B13 |
| Weights (subject of variation) | 14.50 kg |

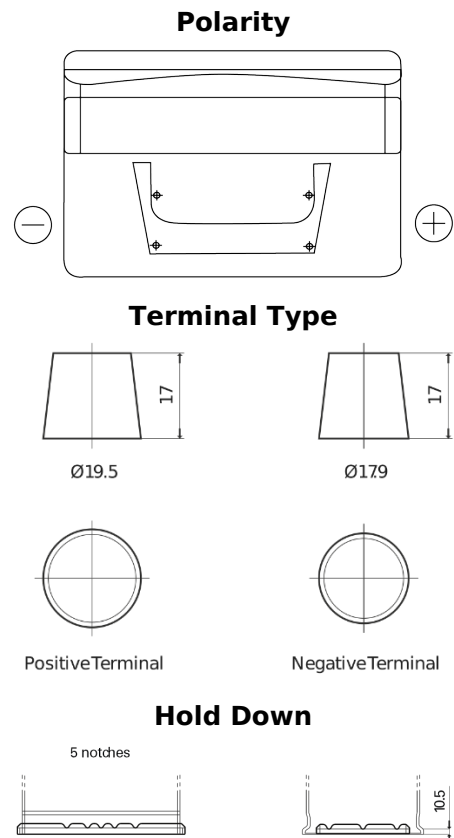

Design, features and specifications are subject to change without notice. We disclaim any representation or warranty, express or implied, concerning the data or recommendations, and in no event shall be liable for any loss or damage claimed to have arisen as a result. Some products may not be available in your local market.