

Product overview

Batteries for Cars

Technica TB604



Part number	TB604
Technology	Flooded
EAN/GTIN	3661024054416
Voltage	12 V
Capacity	60.0 Ah
CCA	480 A
Length	230 mm
Width	173 mm
Height	222 mm
Box size	D23
Polarity	ETN 0
Terminal Type	EN taper post
Hold Down	Korean B1
Weights (subject of variation)	14.60 kg

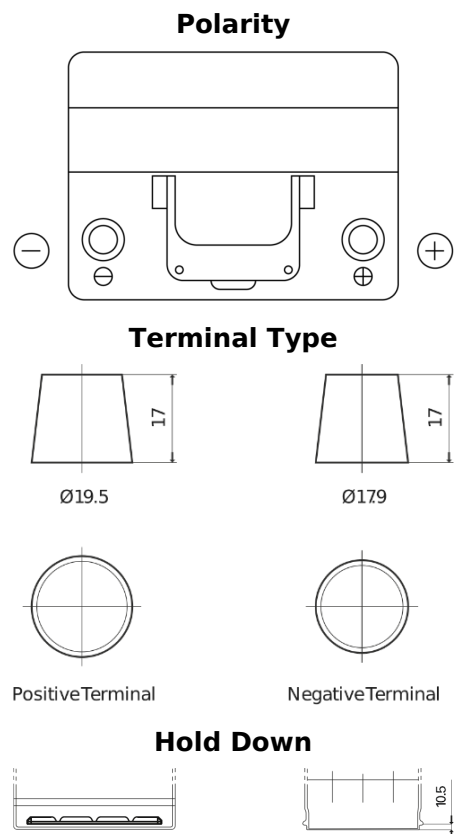

Design, features and specifications are subject to change without notice. We disclaim any representation or warranty, express or implied, concerning the data or recommendations, and in no event shall be liable for any loss or damage claimed to have arisen as a result. Some products may not be available in your local market.