

Product overview

Batteries for Marine and Leisure

Equipment GEL ES950



Part number	ES950
Technology	GEL
EAN/GTIN	3661024035828
Voltage	12 V
Capacity	85.0 Ah
Watt hour	950 Wh
Length	330 mm
Width	171 mm
Height	235 mm
Box size	D02
Polarity	ETN 1
Terminal Type	EN taper post
Hold Down	B0
Weights (subject of variation)	28.20 kg

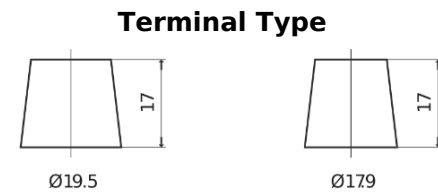
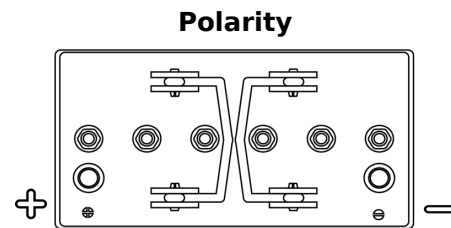

Design, features and specifications are subject to change without notice. We disclaim any representation or warranty, express or implied, concerning the data or recommendations, and in no event shall be liable for any loss or damage claimed to have arisen as a result. Some products may not be available in your local market.