

Batteries for Cars

EFB FL600



Part number	FL600
Technology	EFB
EAN/GTIN	3661024045681
Voltage	12 V
Capacity	60.0 Ah
CCA	640 A
Length	242 mm
Width	175 mm
Height	190 mm
Box size	L02
Polarity	ETN 0
Terminal Type	EN taper post
Hold Down	B13
Weights (subject of variation)	17.00 kg

Polarity

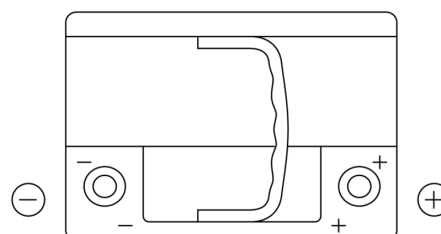

Terminal Type

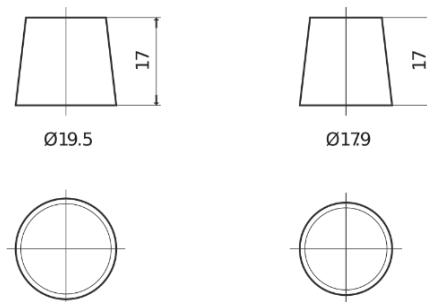

Positive Terminal

Negative Terminal

Hold Down



Design, features and specifications are subject to change without notice. We disclaim any representation or warranty, express or implied, concerning the data or recommendations, and in no event shall be liable for any loss or damage claimed to have arisen as a result. Some products may not be available in your local market.