

**Product overview**

Batteries for Cars

**Power DB501**



Part number	DB501
Technology	Flooded
EAN/GTIN	3661024024525
Voltage	12 V
Capacity	50 Ah
CCA	450 A
Length	207 mm
Width	175 mm
Height	190 mm
Box size	L01
Polarity	ETN 1
Terminal Type	EN taper post
Hold Down	B13
Weights (subject of variation)	12.20 kg

**Polarity**

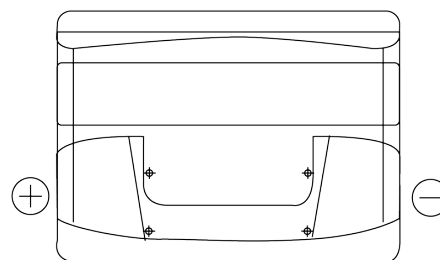

**Terminal Type**



Positive Terminal

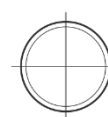

Negative Terminal

**Hold Down**



Design, features and specifications are subject to change without notice. We disclaim any representation or warranty, express or implied, concerning the data or recommendations, and in no event shall be liable for any loss or damage claimed to have arisen as a result. Some products may not be available in your local market.