

**Product overview**

Batteries for Marine and Leisure

**Dual EFB EZ850**



Part number	EZ850
Technology	EFB
EAN/GTIN	3661024037495
Voltage	12 V
Capacity	100 Ah
CCA	900 A
Watt hour	850 Wh
Length	353 mm
Width	175 mm
Height	190 mm
Box size	L05
Polarity	ETN 0
Terminal Type	EN taper post
Hold Down	B13
Weights (subject of variation)	25.50 kg

**Polarity**

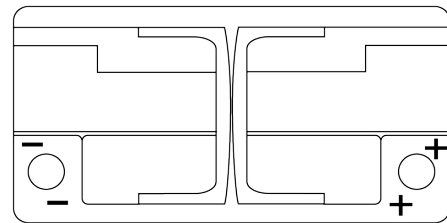

**Terminal Type**

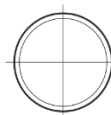
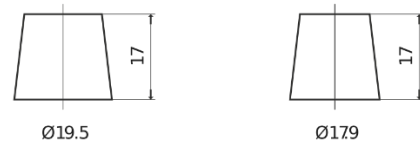

Positive Terminal

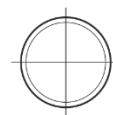

Negative Terminal

**Hold Down**



Design, features and specifications are subject to change without notice. We disclaim any representation or warranty, express or implied, concerning the data or recommendations, and in no event shall be liable for any loss or damage claimed to have arisen as a result. Some products may not be available in your local market.