

Product overview

Batteries for Marine and Leisure

Dual AGM EP600



Part number	EP600
Technology	AGM
EAN/GTIN	3661024036528
Voltage	12 V
Capacity	70 Ah
CCA	760 A
Watt hour	600 Wh
Length	278 mm
Width	175 mm
Height	190 mm
Box size	L03
Polarity	ETN 0
Terminal Type	EN taper post
Hold Down	B13
Weights (subject of variation)	20.60 kg

Polarity

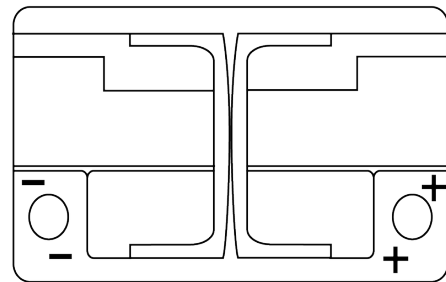

Terminal Type

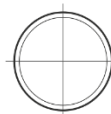
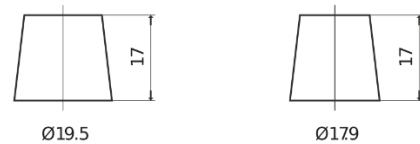

Positive Terminal

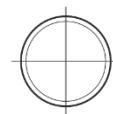

Negative Terminal

Hold Down



Design, features and specifications are subject to change without notice. We disclaim any representation or warranty, express or implied, concerning the data or recommendations, and in no event shall be liable for any loss or damage claimed to have arisen as a result. Some products may not be available in your local market.