

## Product overview

Batteries for Motorcycles, ATVs, Snowmobiles, Garden

### AGM Ready AGM12-11



Part number	AGM12-11
Technology	AGM
EAN/GTIN	3661024037617
Voltage	12 V
Capacity	11 Ah
CCA	205 A
Length	150 mm
Width	90 mm
Height	110 mm
Box size	C74
Polarity	ETN 1
Terminal Type	M04
Hold Down	B0
Weights (subject of variation)	4.10 kg

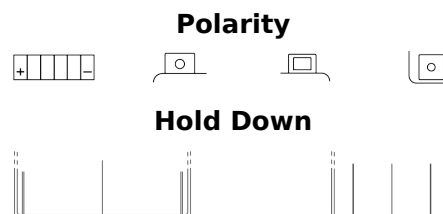

Design, features and specifications are subject to change without notice. We disclaim any representation or warranty, express or implied, concerning the data or recommendations, and in no event shall be liable for any loss or damage claimed to have arisen as a result. Some products may not be available in your local market.