

Product overview

Batteries for Motorcycles, ATVs, Snowmobiles, Garden

Conventional EB12AL-A



Part number	EB12AL-A
Technology	Flooded
EAN/GTIN	3661024033305
Voltage	12 V
Capacity	12.0 Ah
CCA	165 A
Length	135 mm
Width	80 mm
Height	160 mm
Box size	C45
Polarity	ETN 0
Terminal Type	M06
Hold Down	B0
Weights (subject of variation)	4.20 kg

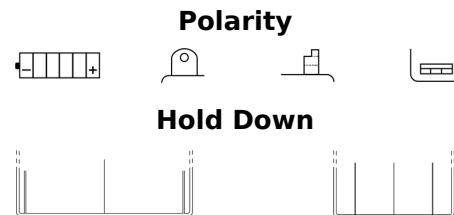

Design, features and specifications are subject to change without notice. We disclaim any representation or warranty, express or implied, concerning the data or recommendations, and in no event shall be liable for any loss or damage claimed to have arisen as a result. Some products may not be available in your local market.