

**Product overview**

Batteries for Cars

**EFB DL1000**



Part number	DL1000
Technology	EFB
EAN/GTIN	3661024026888
Voltage	12 V
Capacity	100.0 Ah
CCA	900 A
Length	353 mm
Width	175 mm
Height	190 mm
Box size	L05
Polarity	ETN 0
Terminal Type	EN taper post
Hold Down	B13
Weights (subject of variation)	25.50 kg

**Polarity**



**Terminal Type**

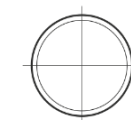

Positive Terminal

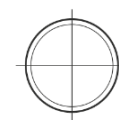

Negative Terminal

**Hold Down**



Design, features and specifications are subject to change without notice. We disclaim any representation or warranty, express or implied, concerning the data or recommendations, and in no event shall be liable for any loss or damage claimed to have arisen as a result. Some products may not be available in your local market.