

Product overview

Batteries for Trucks, Buses, Construction, Agriculture

PowerPRO Agri&Construction EJ050C



Part number	EJ050C
Technology	AGM
EAN/GTIN	3661024036979
Voltage	12 V
Capacity	50 Ah
CCA	800 A
Length	260 mm
Width	173 mm
Height	206 mm
Box size	G34
Polarity	ETN 1
Terminal Type	SAE M 3/8"- 5/16" taper&stud
Hold Down	B7
Weights (subject of variation)	17.90 kg

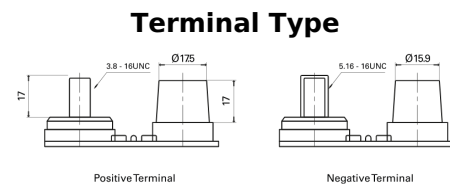
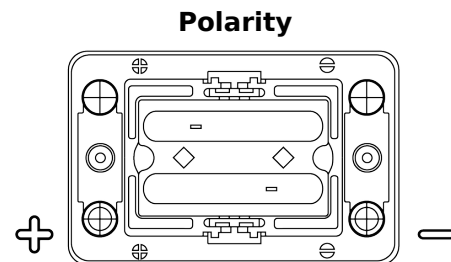

Design, features and specifications are subject to change without notice. We disclaim any representation or warranty, express or implied, concerning the data or recommendations, and in no event shall be liable for any loss or damage claimed to have arisen as a result. Some products may not be available in your local market.