

Product overview

Batteries for Cars

Futura CA406



Part number	CA406
Technology	Flooded
EAN/GTIN	3661024016919
Voltage	12 V
Capacity	40.0 Ah
CCA	350 A
Length	187 mm
Width	127 mm
Height	220 mm
Box size	B19
Polarity	ETN 0
Terminal Type	JIS taper post
Hold Down	B1
Weights (subject of variation)	9.30 kg

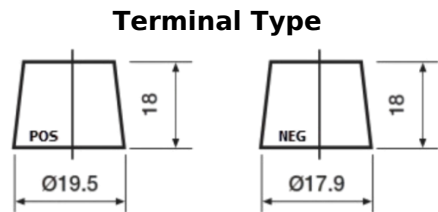
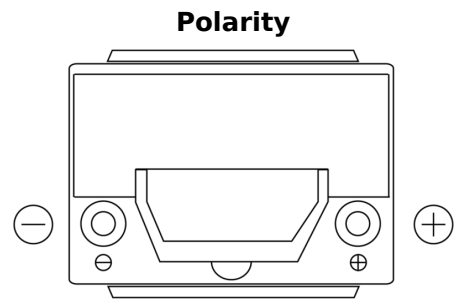

Remove T1 adapter for T3

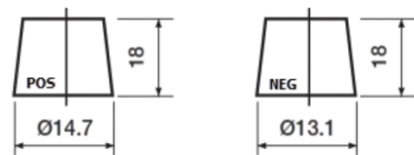

Hold Down



Design, features and specifications are subject to change without notice. We disclaim any representation or warranty, express or implied, concerning the data or recommendations, and in no event shall be liable for any loss or damage claimed to have arisen as a result. Some products may not be available in your local market.