

# Operating Instructions

## Battery Controller

### GNB PRO

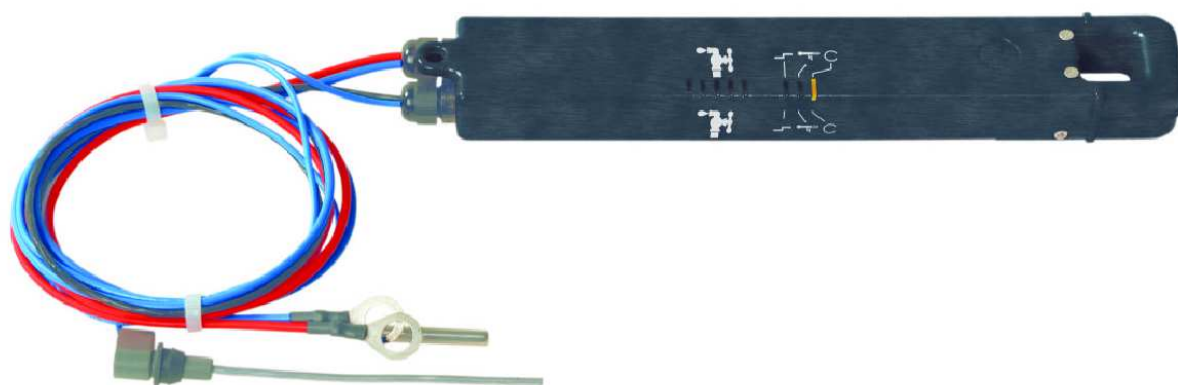

|           | Date       | Name     |  | GNBPRO_1.0EN |
|-----------|------------|----------|--|--------------|
| Issued:   | 08.10.2015 | AB/SZ/KR |  |              |
| Revision: | 1.0        |          |  |              |
| Checked:  |            |          |  |              |

# Contents

|          |   |           |
|----------|---|-----------|
| <b>1</b> | <b>General</b> .....  | <b>4</b>  |
| 1.1      | Purpose of Operating Instructions .....                         | 4         |
| 1.2      | Copyrights and patents .....                                    | 4         |
| 1.3      | Trademarks .....  | 5         |
| <b>2</b> | <b>Safety</b> .....   | <b>5</b>  |
| 2.1      | General .....   | 5         |
| 2.2      | Signs and symbols .....   | 5         |
| 2.3      | Personnel qualifications .....                                  | 6         |
|          | 2.3.1 Commercial use .....                                      | 6         |
| 2.4      | Intended use.....   | 7         |
| 2.5      | Safety instructions concerning installation.....                | 7         |
| 2.6      | Safety instructions concerning operation .....                  | 8         |
| 2.7      | Safety instructions concerning troubleshooting and repair.....  | 8         |
| <b>3</b> | <b>Product details</b> .....                                    | <b>9</b>  |
| 3.1      | Description of the product and its function.....                | 9         |
| 3.2      | Types / Variants .....  | 9         |
| 3.3      | Description of the accessories and their function.....          | 10        |
|          | 3.3.1 RF-Interface (Receiver).....                              | 10        |
|          | 3.3.2 iNFO Guard software .....                                 | 10        |
| 3.4      | Residual risk .....   | 10        |
| 3.5      | Description of protective installations .....                   | 11        |
| 3.6      | Identifications and signs on the GNB PRO.....                   | 11        |
| <b>4</b> | <b>Transport, handling and storage</b> .....                    | <b>11</b> |
| <b>5</b> | <b>Assembly and start-up</b> .....                              | <b>11</b> |
| 5.1      | Scope of delivery .....   | 12        |
| 5.2      | Assembly requirements.....                                      | 12        |
| 5.3      | Assembly.....   | 13        |
| 5.4      | Initialisation and initial start-up of iNFO Guard software..... | 17        |
| <b>6</b> | <b>Operation</b> .....  | <b>18</b> |
| 6.1      | Description of the LED display .....                            | 18        |
| 6.2      | GNB PRO function overview .....                                 | 19        |

|            |   |           |
|------------|---|-----------|
| 6.2.1      | iNFO Guard Software.....  | 19        |
| 6.2.2      | GNB PRO Update (current firmware version 1.03 or higher is required)..... | 21        |
| 6.2.3      | GNB PRO Settings.....   | 21        |
| 6.2.4      | GNB PRO Measurements.....   | 24        |
| 6.2.5      | GNB PRO Charge info.....  | 24        |
| 6.2.6      | GNB PRO Battery report.....   | 25        |
| 6.2.7      | GNB PRO Charge/Discharge recordings.....                                  | 27        |
| 6.2.8      | GNB PRO Save all data.....  | 28        |
| <b>6.3</b> | <b>Faults and error messages.....</b>                                     | <b>29</b> |
| 6.3.1      | Faults.....   | 29        |
| <b>7</b>   | <b>Maintenance.....</b>   | <b>30</b> |
| 7.1        | Cleaning, inspection and maintenance.....                                 | 30        |
| 7.2        | Replacement parts and accessories.....                                    | 30        |
| <b>8</b>   | <b>Disposal / environmental protection.....</b>                           | <b>31</b> |
|            | <b>Appendix.....</b>  | <b>32</b> |
|            | Dimension and overview drawings.....                                      | 32        |
|            | List of symbols and abbreviations.....                                    | 33        |
|            | Technical data.....   | 34        |

# 1 General

## 1.1 Purpose of Operating Instructions

These operating instructions serve to enable the secure operation of the GNB PRO battery controller as intended. The GNB PRO battery controller is referred to in short as "GNB PRO" in the following.

The present Operating Instructions contain the information necessary for the proper operation of the GNB PRO. To ensure the safe and correct operation of the GNB PRO, the user should study these instructions carefully and note all the information contained therein.

Attentive reading and observing the Operating Instructions helps to

- avoid dangers,
- reduce downtimes,
- increase the reliability and service life of the GNB PRO.

The Operating Instructions must always be available and kept handy in the vicinity of the GNB PRO.

The Operating Instructions must be read and applied by any person entrusted with operating processes on the GNB PRO:

- for transport,
- for assembly and start-up,
- for operation,
- for maintenance as well as
- for disassembly.

In addition to the Operating Instructions, the valid applicable guidelines, standards and laws for safe and correct working at the place of installation must be observed in commercial use.

Information in addition to these Operating Instructions can be obtained from the specialists of the manufacturer or supplier.

## 1.2 Copyrights and patents

These Operating Instructions are to be treated confidentially. They should be made accessible only to authorised persons. Disclosure to third parties is only permitted with the express written approval of the manufacturer.

All documentation is protected under copyright law. Disclosure and copying of documentation, even in form of extracts, and utilisation and dissemination of its contents is not permitted unless expressly approved.

Violations are subject to prosecution and payment of damages. The manufacturer reserves all rights for exercising industrial patent rights.

### 1.3 Trademarks

Windows is a registered trademark and Windows 98, NT, Me, 2000, XP and Windows 7 are trademarks of the Microsoft Corporation. All other brands and product names mentioned in this manual are trademarks of their respective owners and are hereby acknowledged.

## 2 Safety

### 2.1 General

The Operating Instructions are an important part of the GNB PRO.

The operator will ensure that the Operating Instructions are always available in the vicinity of the GNB PRO, and that the operating personnel will pay attention to these guidelines.

The Operating Instructions must be supplemented by the operator with Operating Instructions on the basis of existing national regulations for accident prevention and environmental protection including the information concerning supervisory and notification obligations for the consideration of special operational features for instance with regard to work organisation, working processes and personnel employed.

In addition to the Operating Instructions and the valid regulations for accident prevention applicable in the country concerned and at the place of operation it is also necessary to observe the acknowledged rules of technology for safe and correct working.

### 2.2 Signs and symbols

The GNB PRO is manufactured according to the generally acknowledged rules and the current state of the art. Additional safety instructions are provided in order to guarantee the personnel adequate safety. Adequate safety when handling the GNB PRO is ensured only if these instructions are adhered to.

From time to time it is necessary to emphasise certain text passages. The marked passages have different meanings:



#### **Note!**

Notes contain additional information facilitating safe and efficient handling of the GNB PRO.

**Caution!**

This warning draws attention to possible damage to property which may result from a failure to adhere to precautionary measures or from incorrect handling.

Please observe all warnings and measures which prevent the occurrence of damage on the GNB PRO and other property. Proceed with particular care!

**Danger!**

This warning refers to possible injuries to persons which may result due to a failure of adhering to precautionary measures or through incorrect handling.

Please observe all warnings and measures which prevent injuries to yourself or third parties. Proceed with particular care!

## 2.3 Personnel qualifications

Only qualified technical personnel may work on the GNB PRO. Especially the installation, initial start-up, maintenance and disassembly of the power supply system must only be performed by qualified electricians authorised for this purpose.

Qualified technical personnel in the sense of these basic instructions are persons who are familiar with the installation, start-up, operation, maintenance, shut-down and disassembly and who have the qualifications *corresponding to their activity*.

The installation, initial start-up, maintenance and disassembly of the GNB PRO must only be performed by qualified *electricians* authorised for this purpose.

With qualified electricians it must be assumed that the applicable regulations of the local power supply company and the safety instructions of the accident prevention regulations of the trade associations (for instance BGV A3) and all rules for safe and correct working (for instance DIN VDE 0100 and IEC 60664 or DIN VDE 0110) are observed and adhered to.

The manufacturer points out that the manufacturer will not accept any liability for damage and operating faults arising from a failure to observe the Operating Instructions.

### 2.3.1 Commercial use

If the GNB PRO is employed commercially, the following will apply in addition:

- The operator must be familiar with the charging process of lead-acid batteries and their handling through special instruction or training.
- Only authorised personnel may become active.

## 2.4 Intended use

The GNB PRO battery controller is exclusively intended for installation on lead-acid batteries.

The instructions of the battery manufacturer for handling lead-acid batteries must be observed and adhered to!



### **Danger of injury!**

Danger of serious injuries to persons and property may result from:

- incorrect use or incorrect operation,
- impermissible opening of the GNB PRO,
- incorrect installation or incorrect maintenance.

All details concerning intended use, residual risk, installation, operation and maintenance contained in these Operating Instructions must therefore be observed and adhered to.

The GNB PRO should only be used for the applications provided in these operating instructions and in the technical description and only with the accessories or components recommended and approved by the manufacturer.

Use other than this or beyond this will not be considered as intended use. The operator or user of the GNB PRO will carry the sole responsibility for damage resulting from such use.

Starting the GNB PRO is only permitted subject to adherence to the guideline for electromagnetic compatibility (89/336/EEC).

## 2.5 Safety instructions concerning installation

Prior to commencing with the installation, check the scope of delivery for completeness using the enclosed delivery documents. Possible defects must be immediately reported to the manufacturer/supplier.

The GNB PRO must be protected from impermissible loads. In particular, no components must be damaged during transport and handling or the housing opened.

The unit must not be installed in areas where water or battery acid puddles have collected. The ambient temperatures at the place of installation must not be less than  $-10^{\circ}\text{C}$  or exceed  $60^{\circ}\text{C}$ .

The GNB PRO contains electrostatically susceptible components which can be easily damaged through incorrect handling. Electrical components may not be mechanically damaged or destroyed.

Perform the electrical installation (line cross sections, fuses, earth connections) according to the applicable regulations.

Prior to performing the electrical installation, compare the ratings on the rating plate with the ratings of the battery: Adhere to the connection values of the rating plate with regard to the battery voltage.

## 2.6 Safety instructions concerning operation

The GNB PRO may only be used in technically perfect condition and as intended under consideration of safety and hazards and adhering to these Operating Instructions. In particular, faults impairing the safety must be corrected immediately.

The information on the type plate about the permissible battery voltage must be checked prior to the installation and adhered to. Correct connection of the GNB PRO supply lines must be ensured.

In the event of safety-relevant changes to the GNB PRO or the operating behaviour, the GNB PRO must be stopped immediately and the fault reported to the responsible office.

## 2.7 Safety instructions concerning troubleshooting and repair

Use only voltage-insulated tools for performing maintenance work.

Before starting any maintenance work inside the unit, the GNB PRO must be disconnected from the battery.



### Caution!

If the GNB PRO housing is opened and then closed again, it is essential that a new seal is placed into the groove of the housing cover in order to ensure that the protection class is maintained!

Adequate protection must be provided against short circuits (electric arc) or direct contact with live components depending on the battery's nominal voltage. The measures taken by the battery manufacturer designed to secure this requirement must be checked for correctness, completeness and effectiveness.

No changes, attachments and conversions which may impair the safety may be performed on the GNB PRO without the approval of the manufacturer! Especially ensure that distances, creep and air gaps are not reduced.

Replacement parts used must satisfy the technical requirements determined by the manufacturer. This is always ensured when using original replacement parts.



### 3 Product details

#### 3.1 Description of the product and its function

The battery controller GNB PRO is a system for the recording, storage, signaling and evaluation of important operation data from lead-acid traction batteries. The GNB PRO is installed directly on the battery for this purpose.

The GNB PRO consists of microcontroller-controlled electronics. The electronics are installed in a stable and battery-acid resistant plastic housing (protection class IP 65). Two measuring and supply lines ensure the battery voltage measurement is correct and also serve as the power supply at the same time. The GNB PRO uses an electrolyte level sensor to detect whether the battery acid level is too low. A temperature sensor, which is inserted between the battery cells, completes the measurement equipment.

LEDs signalise the unit status, the current remaining capacity and the electrolyte level of the battery.

The GNB PRO is provided with a built-in radio interface for communication. The radio interface works with a frequency of 2.4 GHz, which means it operates in the released ISM frequency band.

#### 3.2 Types / Variants

|               |  |
|---------------|--|
| Type:         | Use:   |
| GNB PRO 250A  | recommended for EPzS $\leq$ 775 Ah // TCSM $\leq$ 840 Ah |
| GNB PRO 500A  | recommended for EPzS $>$ 775 Ah // TCSM $>$ 840 Ah       |
| GNB PRO 1000A | not in use   |

| I_nominal<br>[A] | Measuring Range<br>Charging [A] |       | Measuring Range<br>Discharging [A] |      |
|------------------|---------------------------------|-------|------------------------------------|------|
|                  | von                             | bis   | von                                | bis  |
| 250              | -2                              | -500  | 2,5                                | 1000 |
| 500              | -4                              | -1000 | 5                                  | 2000 |
| 1000             | -8                              | -2000 | 10                                 | 4000 |

From a current value of  $>10$  A at Charge & Discharge in the range continuous current is counted in the active hour counter. Under 10 A Idle-time is counted in the range. The ampere hours are calculated from the smallest to the largest current values regardless of the time counter and counted.

### 3.3 Description of the accessories and their function

#### 3.3.1 RF-Interface (Receiver)

The interface converter can be connected to standard PCs or notebooks, provided these are provided with a standard USB interface (at least USB version 1.1). For more information about connecting and operating the interface converters, refer to section 6.2.1.

#### 3.3.2 iNFO Guard software

iNFO Guard software is required to read out the data via the charger and to reset the internal counters.

System requirements:

- Standard PC or notebook with an USB 1.1 or 2.0 interface and CD-ROM drive
- Operating systems: Windows® 2000/XP/XP-SP2/Windows® 7
- Interface converter: see section 3.3.1

### 3.4 Residual risk



#### **Dangerous electrical voltage warning!**

The GNB PRO is a piece of electrical equipment carrying voltages and currents which are dangerous to human beings.

For this reason, the GNB PRO must only be installed and disassembled, if required, by qualified *electrical* personnel!

As a general rule, the supply lines must be interrupted before performing any actions and work on the GNB PRO.



#### **Explosion hazard!**

Explosive and caustic gases may escape during battery charging.

*Never* remove the supply lines during a charging or discharging process. This could result in sparks, which could ignite the oxyhydrogen gases.

Make sure that the housing of the GNB PRO is always tightly closed to prevent the ingress of acids or acid gases into the unit.



#### **Caution!**

If the GNB PRO is connected with the wrong polarity or connected to a battery with a too high nominal voltage, it may result in damage to the GNB PRO and the battery.

Always check whether the GNB PRO is connected to the correct poles and is suitable for your battery type. If in doubt, contact the competent service station of the operator.

### 3.5 Description of protective installations

The GNB PRO has been designed and built according to the acknowledged rules of technology. If used as intended, there are no consequent safety and health hazards to operating personnel or third parties.

All live components are located in the housing, which can only be opened by means of a tool. All cables and connecting lines are isolated correctly. The GNB PRO is designed according to protection class IP 65 (dust-tight and protected against water jets).

The GNB PRO has the CE marking; all insulation distances have been adhered to.

### 3.6 Identifications and signs on the GNB PRO

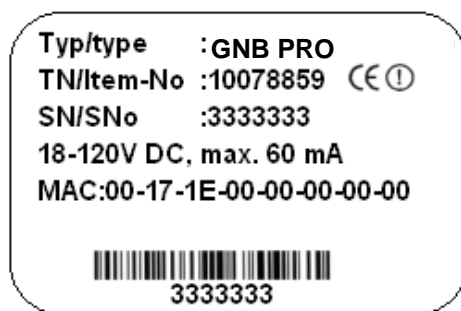

#### Rating plate

Attached to the back of the unit.

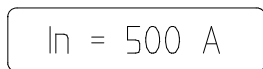

#### Sign Measuring range

On the rear panel. (for example, 500 A)

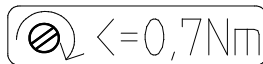

#### Sign Torque

On the rear panel.

## 4 Transport, handling and storage

The GNB PRO is delivered packed in a cardboard box.

During transport, handling and storage, the GNB PRO must be protected against extreme temperatures (too high or too low) and against extremely high mechanical loads.

## 5 Assembly and start-up



#### Dangerous electrical voltage warning!

The GNB PRO is a piece of electrical equipment carrying voltages and currents which can be dangerous to human beings.

For this reason, the GNB PRO must only be installed, and disassembled by qualified *electrical* personnel!

As a general rule, the supply lines must be interrupted before performing any actions and work on the GNB PRO.

### 5.1 Scope of delivery

The delivery consists at least of the following parts:

- GNB PRO,
  - the connected supply lines,
  - the connected temperature sensor,
  - the connected electrolyte sensor
  - the delivery note.
- Immediately after delivery, check for completeness and damage.
  - Use the delivery note and the rating plate to check if the data match.
  - If there are defects, immediately contact the manufacturer and the transport company if applicable.
  - Check the GNB PRO for loose screw connections and secure them, if required.

### 5.2 Assembly requirements

The GNB PRO is installed directly on the battery. The housing is made of acid resistant plastic. The unit corresponds to protection class IP 65 and is dust and water tight and acid resistant.

Avoid installing the GNB PRO directly in areas contaminated by battery acid residues. Clean the battery surface before, if necessary

### 5.3 Assembly



**Explosion hazard!**

Danger of serious injuries to persons and property. Explosive and caustic gases may escape during battery charging!

Make sure before the assembly that the battery does not gas. The battery must not be charged or discharged during assembly! If necessary, the battery must be ventilated sufficiently before assembly!



**Caution!**

Make sure to follow the battery manufacturer's safety guidelines and the general security guidelines for handling lead-acid batteries.

When performing work on the battery, make sure to wear protective goggles, rubber gloves and protective clothing!

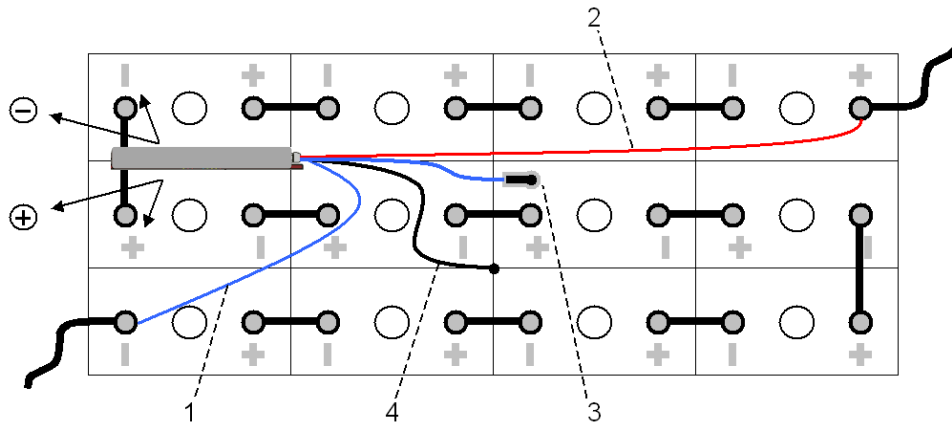

**GNB PRO installation on a battery (example)**

- 1 – Blue connecting cable (minus);
- 2 – Red connecting cable (plus);
- 3 – Electrolyte sensor
- 4 – Temperature sensor

The GNB PRO is installed on the battery in the following sequence:

1. Connect the blue connecting line with the negative pole of the battery and the red connecting line with the positive pole of the battery. The connection should be as shown in the following figure:

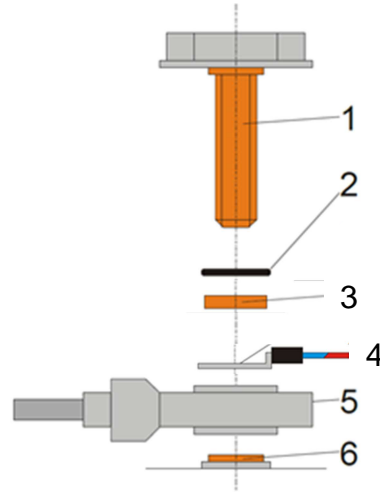

1. Pole screw; 2. O-ring; 3. Copper Spacer Terminal; 4. Special ring cable lug V4A GNB PRO (red or blue, depending on pole); 5. Cell-connector; 6. Negative or positive pole.

2. Push the temperature sensor in the centre between 4 battery cells (if possible, not at the outer wall of the container). The temperature sensor should only be inserted by a maximum of up to  $\frac{1}{2}$  cell height to avoid direct contact with any possible acid residue.
3. The electrolyte sensor should also be installed in the middle of the battery. The warmest cell should preferably be chosen, since this is where the most electrolyte is likely to be lost. However, in order to operate correctly, the electrolyte sensor must be installed on at least three cells away from the negative terminal!

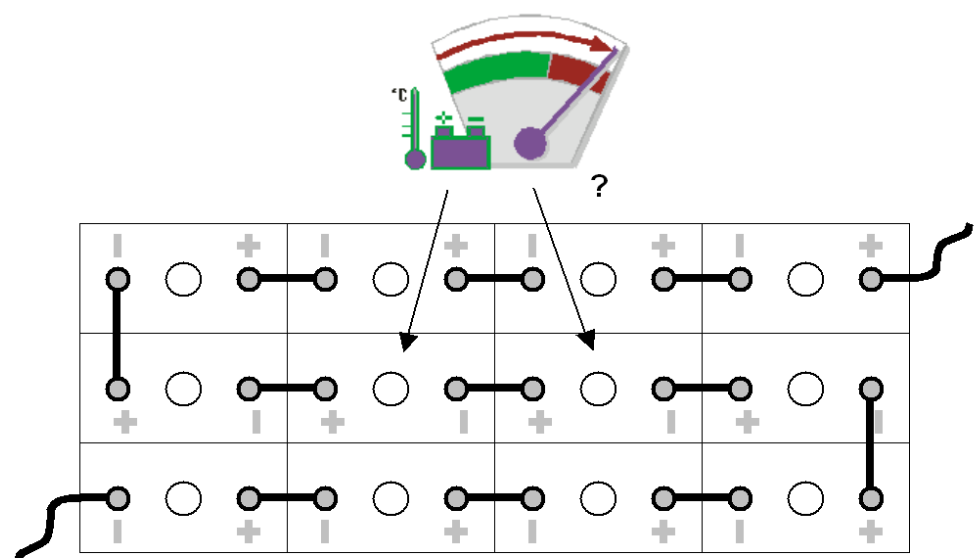



**Caution!**

An installation position in the vicinity of the third or fourth cell after the negative terminal is required chosen for batteries with flat plates (US standard). This installation position must be noted in the GNB PRO settings using the iNFO Guard software for batteries with flat plates (see point 5.3)!

4. In the case of PzS cells (DIN cells), the electrolyte sensor must be installed in the corner behind the negative pole. Most batteries are provided here with predefined diagnostic openings.  
In the case of PzB cells (British standard), the electrolyte sensor must be installed in the centre between the negative pole and the refill opening.  
**Note:** Assembling with 2 EPzB and 3 EPzB type not possible.

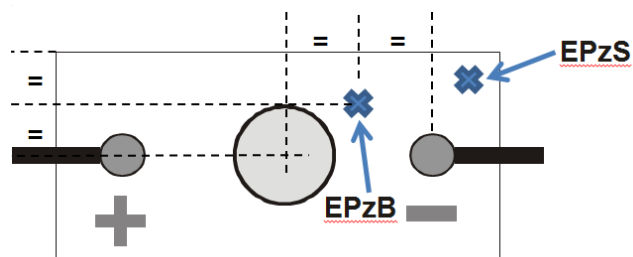

5. In case of PzS (DIN) cells the predefined diagnostic openings have to be punched out with a special diagnostic opener.

In case of PzB (BS) cells using a 12mm drill, drill a hole at the previously determined position for the electrolyte sensor

**Note: The depth of the hole must not be too deep because otherwise the plates or separators in the cell could be damaged! If necessary, use a stop ring (see figure) or a special drill. Do not allow any chips to fall into the cell!**

**PzS (DIN) cells**

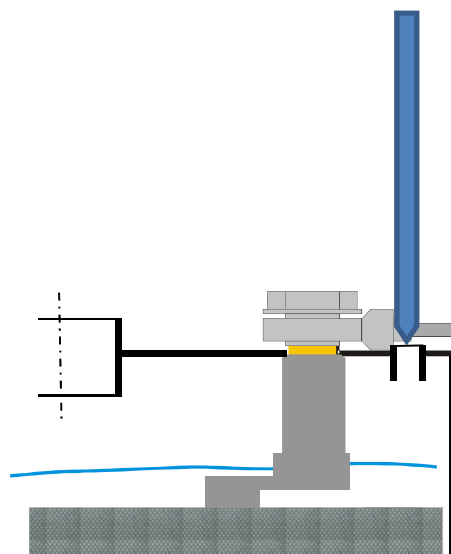

**PzB (BS) cells**

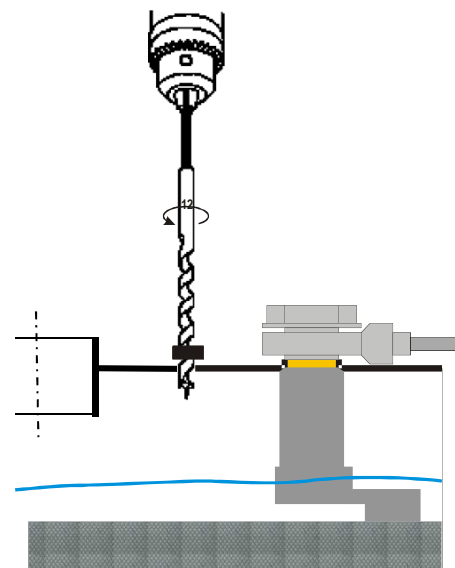

6. Measure the distance  $l$  from plug opening to separator, as shown in the following figure.

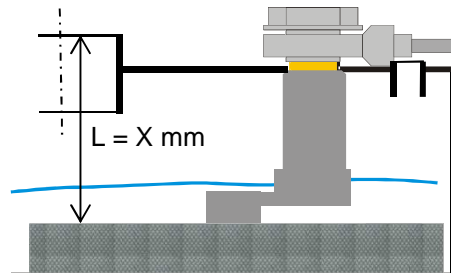

7. Shorten the electrolyte sensor by the determined length – 10mm using a saw with an angle of  $45^\circ$ .

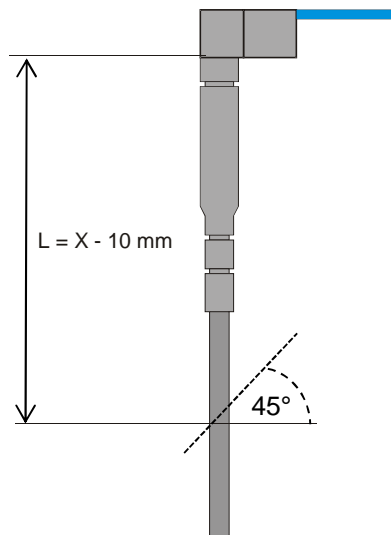

8. In case of PzS cell press the electrolyte sensor directly in the diagnostic hole.  
In case of PzB cell press the supplied wheather seal into the opening.  
Next, push the electrolyte sensor into the cell until it stops.

**PzS (DIN) cell**

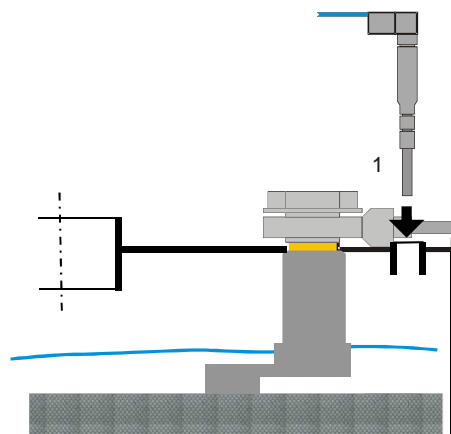

**PzB (BS) cell**

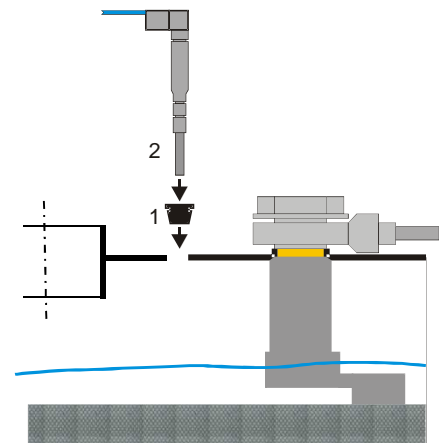



9. The distance between the lower edge of the electrolyte sensor and the upper edge of the separator will be app. 3mm.
10. Slacken screw at the measuring head of the GNB PRO and remove completely.
  - Pull measuring head out of basic housing in a straight position.
  - Then slide measuring head over a suitable cell connector or the end bypass,
  - Now put the housing back onto the measuring head. The measuring head engages audibly ("click") in the basic housing.

**Note!**

Ensure that polarity is correct! In other words, the plus sign on the GNB PRO housing must be facing the positive terminal of the next cell, and the minus sign on the rear of the GNB PRO housing must be facing the negative terminal of the next cell. If the polarity is incorrect the charging and discharging currents will be measured the wrong way round!

11. The retaining bolt of the measuring head must now be screwed into the opening of the housing and loosely tightened (max. tightening torque 0.7 Nm).
12. The GNB PRO can be secured with suitable cable ties (acid-resistant). Then check that all cables/lines are properly attached.

All LEDs should illuminate after the connection has been made. After about 2 seconds all LEDs go off and one of the Electrolyte lack LEDs starts to illuminate. After another 2-3 seconds the operating LED illuminates.

#### **5.4 Initialisation and initial start-up of iNFO Guard software**

Basically, it is not necessary to initialise or program the GNB PRO. The GNB PRO detects the battery voltage automatically and adjusts itself accordingly. Only wet batteries with nominal voltages of 24, 36, 48, and 80V are detected. If required, it is possible to change the battery code and/or enter the battery nominal capacity (see also section 6.2.3).

## 6 Operation

The individual operating steps are explained in more detail in the following chapters. Prior to operating the GNB PRO for the first time, carefully read these sections.

### 6.1 Description of the LED display

The GNB PRO is provided with a display with a total of 8 LEDs. The following table explains the meaning of the individual LEDs.

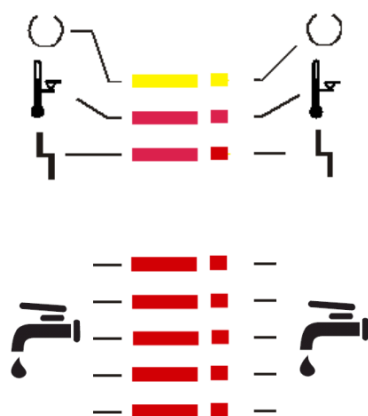







Figure 1: GNB PRO LEDs

| Symbol | Meaning                | Colour | Description   |
|--------|------------------------|--------|---|
|        | Operating mode display | Yellow | <p>Lights if the unit is ready for operation and no unit is connected with the GNB PRO (the LED is extinguished every 5 minutes for a short time to reinitialise the radio network)</p> <p>Flashes if the GNB PRO is connected with a unit (charger, data collector etc.).</p> <p>Off the GNB PRO is not ready for operation (no radio network can be established).</p> |
|        | OVER-TEMPERATURE       | Red    | <p>Lights as soon as the battery temperature exceeds 55°C.</p> <p>Off if the battery temperature is lower than 55°C or, after the temperature has been exceeded (T&gt;55°C), a temperature of 45°C is fallen short of again.</p>  |
|        | Fault                  | Red    | <p>Lights if an error has occurred when establishing a radio network</p> <p>or</p> <p>the temperature at the temperature sensor is greater than 100°C or the sensor lead is defective</p> <p>or</p> <p>the temperature at the temperature sensor is lower than -30° or the sensor lead is short-circuited.</p>  |

| Symbol  | Meaning          | Colour  | Description   |
|---|------------------|---|---|
|  | Electrolyte lack | Red   | Is displayed if the electrolyte level is low.   |
|   |                  |    | The electrolyte lack LEDs indicate the electrolyte lack as follows:                   |
|   |                  | Red   | <b>LED</b>  |
|   |                  |    | 1. LED lights   |
|   |                  | Red   | Electrolyte lack is present, but the set time to save this event has not reached yet. |
|  | Red              | All LEDs flash red  |   |
|  | Red              | Electrolyte lack is present and the set time to save this event is reached or passed. This event is stored in the event memory permanently. |   |
|  | Red              | Off when the electrolyte level in the cell is sufficient.   |   |

## 6.2 GNB PRO function overview

As a data recording, storage and evaluation unit, the GNB PRO offers a series of functions which are explained in more detail in the following sections. The traction monitor software is the basis for the explanation of the functions. More information about handling the software is given in the corresponding online help function.

### 6.2.1 iNFO Guard Software

The iNFO Guard software will started by double-clicking on the desktop link, and the computer is connected with an RF interface 3.3.1, the connected RF interface appears inside the tree structure on the left-hand side of the window.

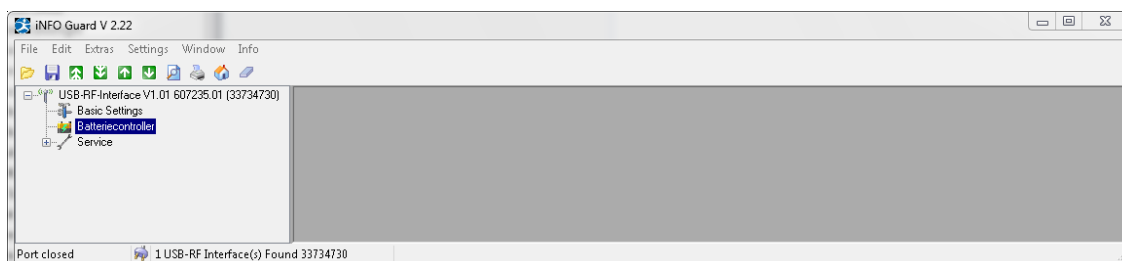

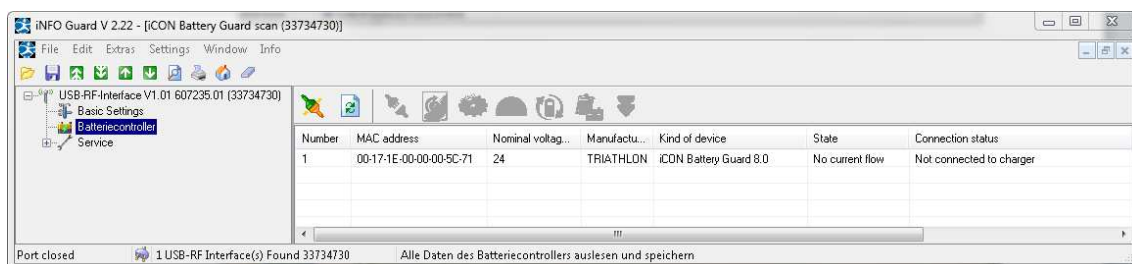

Double-clicking on the symbol or the "GNB PRO" logo opens the GNB PRO Scan window. All possible radio channels for the GNB PRO are automatically interrogated via the RF interface, and the GNB PRO devices that are within range are displayed in a list. A progress bar at the bottom edge of the screen provides information about the progress of the query.











The following values are displayed for the GNB PRO:

- Number Consecutive numbering
- MAC address MAC address of respective GNB PRO  
*Note: each MAC address is unique!*
- Rated voltage Rated voltage to which the GNB PRO has set itself.
- Manufacturer Name of manufacturing company.
- Unit type GNB PRO (build version)
- Status Current flow information
- Connection status Information about the current connection status of the respective
  
- Battery identifier Currently programmed battery identifier (battery identification). The last 6 digits of the MAC address are stored as the battery identifier as standard.
- Channel Display of radio channel on which the respective GNB PRO is transmitting.
- Beacon Payload Version number of internal device software.  
version

In order to make the connection to a GNB PRO in the list, the required GNB PRO must be selected in the list (clicked on once). The connection is then established using the  "Establish connection to this GNB PRO" button or by double clicking on the GNB PRO.

If the required GNB PRO does not come into radio range until later, another search is carried out by clicking on the  "Update GNB PRO list" button and the list is updated.

Once a connection has been successfully established, the following additional buttons are active:

-  Disconnects the current connection to the GNB PRO
-  Starts an update of the GNB PRO firmware
-  Opens the overview window for the general settings and functions of the GNB PRO
-  Starts a measurement and displays the measuring data on the screen in tabular or graphical format.
-  Opens a window containing the current statistical, basic and event data of the GNB PRO.
-  Provides a quick overview of the current charge
-  Opens a window containing the charge / discharge recordings
-  Save all (Settings, Battery report and Charge/Discharge recordings)

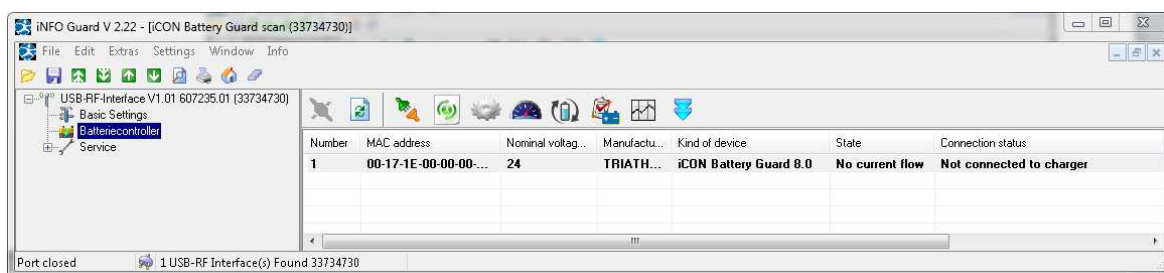

### 6.2.2 GNB PRO Update (current firmware version 1.03 or higher is required)

This button can be used to update the GNB PRO firmware. Caution! A firmware update will delete all stored data!

### 6.2.3 GNB PRO Settings

Information about the battery and about the functionality and values of GNB PRO can be set and stored in the Settings window.

**Please note these defaults in the appropriate fields!**

The battery voltage is automatically detected (ctrl & alt with right mouse click on battery voltage> manually).

Enter the nominal battery capacity indicated on the nameplate.

For battery ID enter the 7 digit serial number of the battery.

For manufacturer code enter the type of battery by internal specification:  
(Example: 10EPzS1200)

For vehicle identification enter of vehicle and vehicle number.

Manufacturing and commissioning enter the date and time. Enter the date and time of the installation of the controller.

Guaranteed Capacity calculate and enter. ( $C_{\text{nominal}} \times 0.8 \times 1200$  cycles)

Setting Event Definition:    Electrolyte:    03: 00: 00: 00,  
   Full charge:    00:05:00 & 2.35 V / Z,

General remarks:

- Nominal battery voltage The nominal battery voltage can be set here.
- Nominal battery capacity Nominal capacity of battery.
- Battery identifier Programmed battery identifier (max. 7 alphanumeric characters possible). The last 6 positions of the MAC address are preset in the factory.
- Manufacturer identifier Information about the manufacturer identifier.
- Vehicle identifier Information about the vehicle identifier.
- Battery manufacturing date Information about the manufacturing date.
- Start-up date Information about the start-up date.
- Guaranteed capacity Information about the guaranteed battery capacity which can be removed from the battery (according to the manufacturer's information).  
(Note: Once the guaranteed capacity has been set, the value cannot be changed again. However, it is possible to reset the value to 0Ah in the Offset window.
- Software version Information about the internal controller software.
- MAC address MAC address of GNB PRO (preset in the factory).
- Date/time Date and time when reading out took place (system time of PC/laptop).
- Synchronise with PC This can be used to determine whether the system time of the computer is to be transmitted to the GNB PRO
- Installation position This confirms that the installation position of the electrolyte sensor is in accordance with the description for flat plate batteries 5.3. If this point has been activated, an appropriately suitable measuring procedure is used.
- Number of cell connectors The number of parallel cell connectors is entered in these fields, since the current measuring head of the GNB PRO can usually only record the current of a cell connector.
- Charge factor This can be used to determine the charge factor to be taken into consideration when determining the charge condition using the charged Ah.

Charging programme

- Charger This can be used to define with which charger type the GNB PRO will communicate.
- Charging program 1 Depending on the previously selected charger types, a charge program can be selected here which bypasses the first set charge program in the charger.
- Charging program 2 Depending on the previously selected charger types, a charge program can be selected here which bypasses the second set charge program in the charger.

Low electrolyte detection

- Duration The time for which low electrolyte must be continuously present for low electrolyte to be stored.

Full charge detection

- Duration The time for which the set full charge detection voltage must be continuously exceeded for full charging to be detected.
- Voltage The voltage which must be continuously exceeded for the set full charging duration for full charging to be detected.

- 
- Without charger ref. If this event memory structure is selected, no information for the charger on which the battery was charged is stored in the history data. In this case, 2000 events can be stored in the event memory.
  - With charger ref. If this event memory structure is selected, information for the charger on which the battery was charged is also stored in the history data. However, a prerequisite for this is the use of a charger from the TriCom Select range with an installed radio module. In this case 1000 entries can be stored in the event memory, together with assignment of the respective charger.

 The event memory, the statistics counter, the Ah counter and the guaranteed capacity can be deleted or reset using this button.

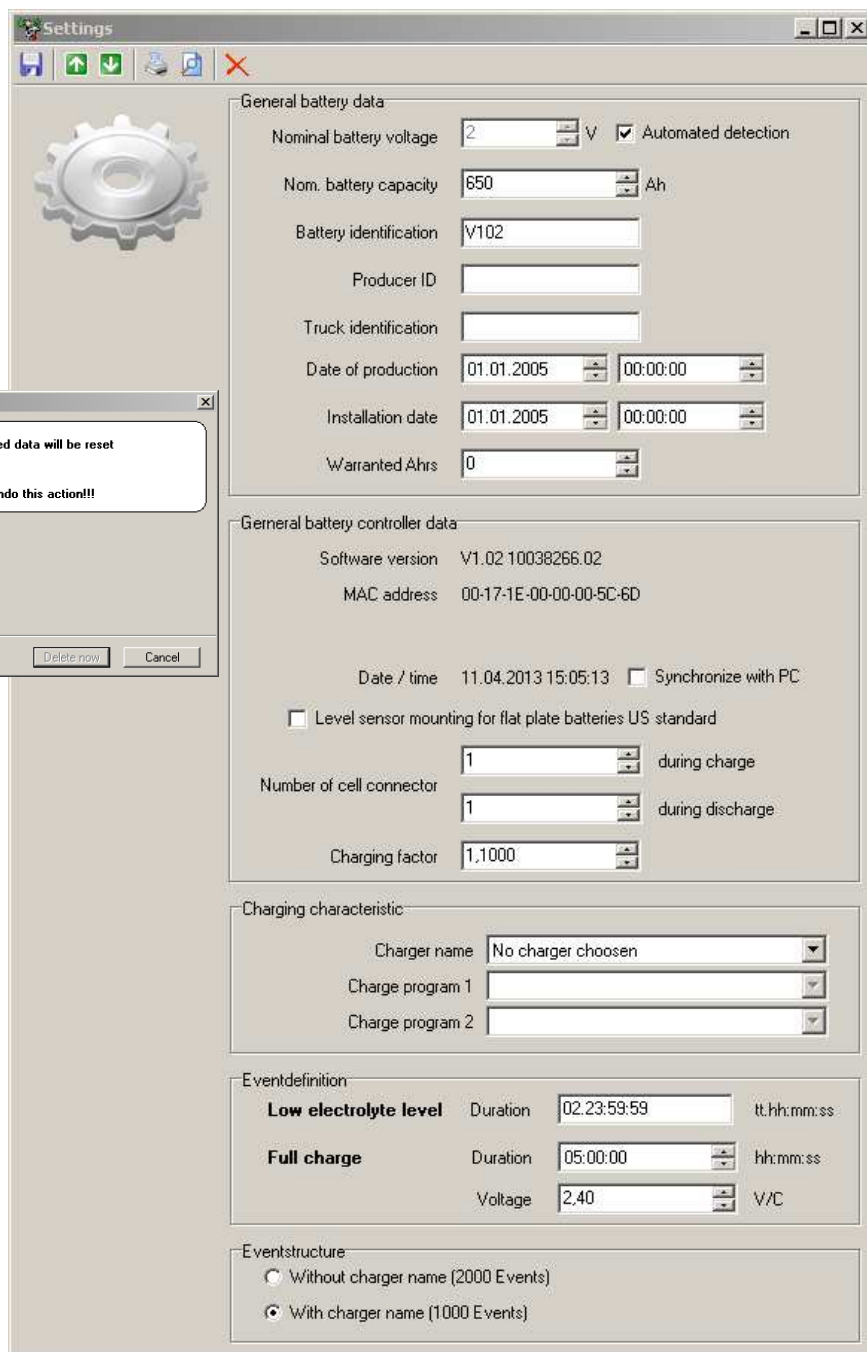
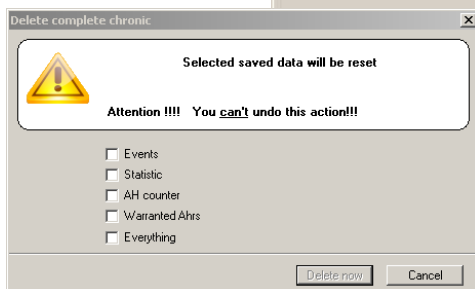

With the key combination (Ctrl. + ALT + right mouse button on battery voltage), the battery voltage is programmable.

It is possible to save the data, export it in other formats or print it.

### 6.2.4 GNB PRO Measurements

The software records the following measurements in the measurement window at 5 second intervals

- No. Number of data record (incremented cyclically).
- Date/Time Date and time of data record.
- Remaining capacity Current remaining capacity.
  
- Battery voltage Current battery voltage in volts.
- Battery temperature Current battery temperature in °C.
  
- Electrolyte level Indication of whether electrolyte level is OK (yes) or not OK (no)  
*(Note: Low electrolyte is indicated with not OK (no) if this status has been present for longer than the time defined in the settings 6.2.4).*
  
- Current Latest current level.

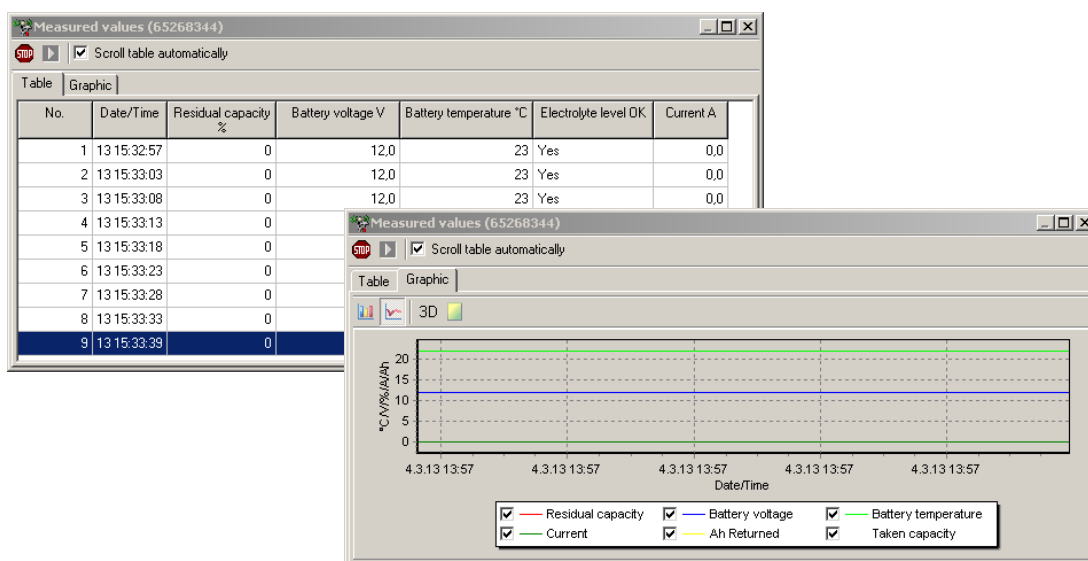

The relevant measurements are graphically displayed in the graphical charging completion data view. The respective view can be adapted individually by revealing or hiding the individual values.

The table data and the diagram can be exported by clicking on the table or the diagram with the right mouse button.

### 6.2.5 GNB PRO Charge info

The most important information about the current charging procedure can be displayed in the charge information window. This information can be read out in GNB PRO again and updated using the "Update" button.

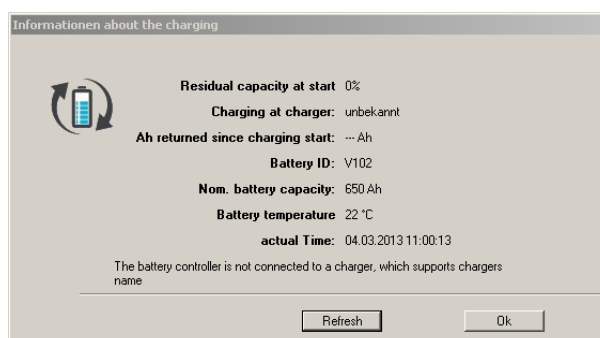



6.2.6 **GNB PRO**  **Battery report**

Parameter and data settings and events are displayed in the "Battery Report" window.

**Settings:**

- Nominal battery voltage Shows the nominal battery voltage setting.
- Nominal battery capacity Shows the nominal battery capacity setting.
- Battery identifier Shows the nominal battery identifier setting.
- Manufacturer identifier Shows the manufacturer identifier setting.
- Vehicle identifier Shows the vehicle identifier setting.
- Battery manufacturing date Shows the manufacturing date setting.
- Start-up date Shows the start-up date setting.
- Date/time Date and time when reading out took place (system time of computer).
- Charge status Charge status of battery in %.
- Number of cycles Number of cycles.
- Guaranteed capacity Indicates the set guaranteed battery capacity that can be removed from the battery.
- Remaining guaranteed capacity Capacity that can be removed from the battery before the guaranteed capacity limit is reached.
- Software version Information about internal controller software.
- MAC address MAC address of GNB PRO (preset in the factory).
- Operating time Duration for which GNB PRO is attached to battery.

**Events:**

All events

- Quantity Sum total of all events.

Charge operation

- Number of full charges Sum total of all full charges.
- Number of intermediate charges Sum total of all intermediate charges.
- Total charge time Total duration of all charge times. *Note: if the battery is charged using a charger without a radio interface, the charge timer runs until the next discharge is detected!*
- Sum total of charged capacity Sum total of all charged Ah.
- Currently charged capacity Sum total of charged Ah of current charge.

Discharging operation

- Total discharge time Sum total of all discharge times. *Note: As soon as the residual capacity is reduced by discharging, the discharge timer starts and runs until recharging is detected.*
- Sum total of removed capacity Sum total of all removed Ah.
- Currently removed capacity Sum total of removed Ah of current discharge.

Deep discharge

- Number Number of deep discharge occurrences
- Duration Total duration of battery in deep-discharged condition

Low electrolyte level

- Quantity Sum total of low electrolyte level occurrences  
*Note: This event is not counted until the condition has been continuously present for at least one hour.*
- Duration Total duration of low electrolyte level

Low temperature

- Quantity Total number of low temperature occurrences.
- Duration Total duration of low temperature.

High temperature

- Quantity Total number of high temperature occurrences.
- Duration Total duration of high temperature.

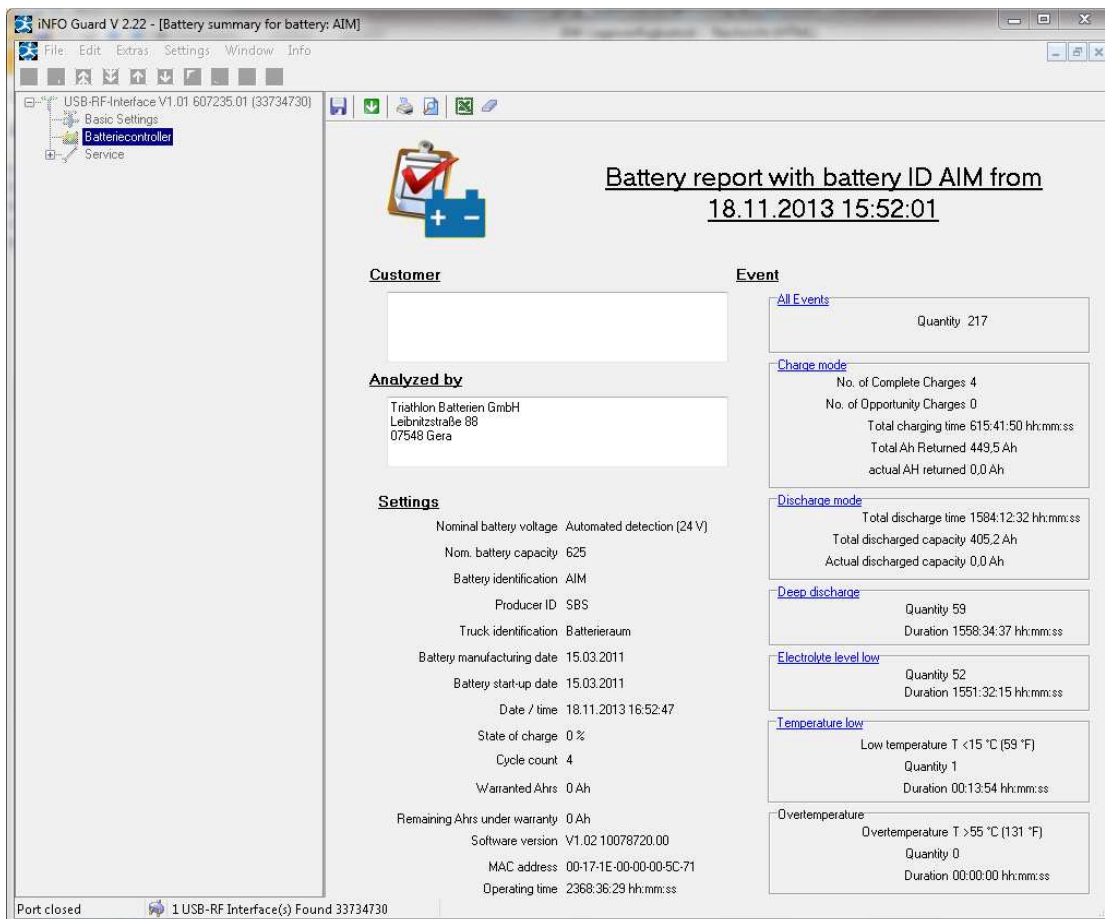

 This button can be used to export all settings, data and events into an Excel file. However Microsoft Excel must be installed on the relevant PC to do this.

 The event memory can be deleted by using this button. This function can be helpful when the application of the battery changes and an evaluation should be done separately for the new application. You will be prompted to save the events locale before the events can be deleted inside the GNB PRO.

The statistics counter, the Ah counter and the guaranteed capacity will not be deleted by using this button.

It is possible to save the data, export it in other formats or print it.

Provided that the number of events in an event group is greater than zero, the group heading is displayed in blue and underlined. Clicking on this group heading opens a window containing a tabular list of all events for this group.

| Number | Id                          | Date/Time           | Battery voltage [V] | Battery current [A] | Battery temperature [°C] | State of charge [%] | Amperhours [Ah] | Idletime [hh:mm:ss] |
|--------|-----------------------------|---------------------|---------------------|---------------------|--------------------------|---------------------|-----------------|---------------------|
| 1      | Stop electrolyte level low  | 21.02.2013 15:16:37 | 11,87               | 0                   | 24                       | 0                   | 0               | 00:00:00            |
| 2      | Power up                    | 22.02.2013 11:17:53 | 12,04               | 0                   | 25                       | 0                   | 0               | 01:42:29            |
| 3      | Start deep discharge        | 22.02.2013 11:17:58 | 12,05               | 2                   | 24                       | 0                   | 0               | 00:00:00            |
| 4      | Power up                    | 25.02.2013 07:31:45 | 12,04               | 0                   | 25                       | 0                   | 0               | 01:42:29            |
| 5      | Start deep discharge        | 25.02.2013 07:31:49 | 12,05               | 0                   | 23                       | 0                   | 0               | 00:00:00            |
| 6      | Power up                    | 26.02.2013 08:10:46 | 12,04               | 0                   | 25                       | 0                   | 0               | 01:42:29            |
| 7      | Start deep discharge        | 26.02.2013 08:10:50 | 12,04               | 2                   | 24                       | 0                   | 0               | 00:00:00            |
| 8      | Start electrolyte level low | 01.03.2013 07:24:07 | 11,85               | 0                   | 22                       | 0                   | 0               | 00:00:00            |
| 9      | Power up                    | 01.03.2013 10:06:56 | 11,86               | 0                   | 25                       | 0                   | 0               | 01:42:29            |
| 10     | Power up                    | 01.03.2013 10:07:16 | 11,89               | 0                   | 25                       | 0                   | 0               | 01:42:28            |
| 11     | Start deep discharge        | 01.03.2013 10:07:20 | 11,89               | 2                   | 24                       | 0                   | 0               | 00:00:00            |
| 12     | Power up                    | 01.03.2013 10:07:25 | 11,87               | 0                   | 25                       | 0                   | 0               | 01:42:28            |
| 13     | Start deep discharge        | 01.03.2013 10:07:29 | 11,88               | 2                   | 24                       | 0                   | 0               | 00:00:00            |
| 14     | Power up                    | 01.03.2013 10:08:18 | 11,96               | 0                   | 25                       | 0                   | 0               | 01:42:29            |
| 15     | Power up                    | 01.03.2013 10:08:23 | 11,96               | 0                   | 25                       | 0                   | 0               | 01:42:29            |

The data can simply be printed or exported into other formats for further use from this tabular list.

### 6.2.7 GNB PRO Charge/Discharge recordings

All saved charge and discharge activity is displayed in this window.

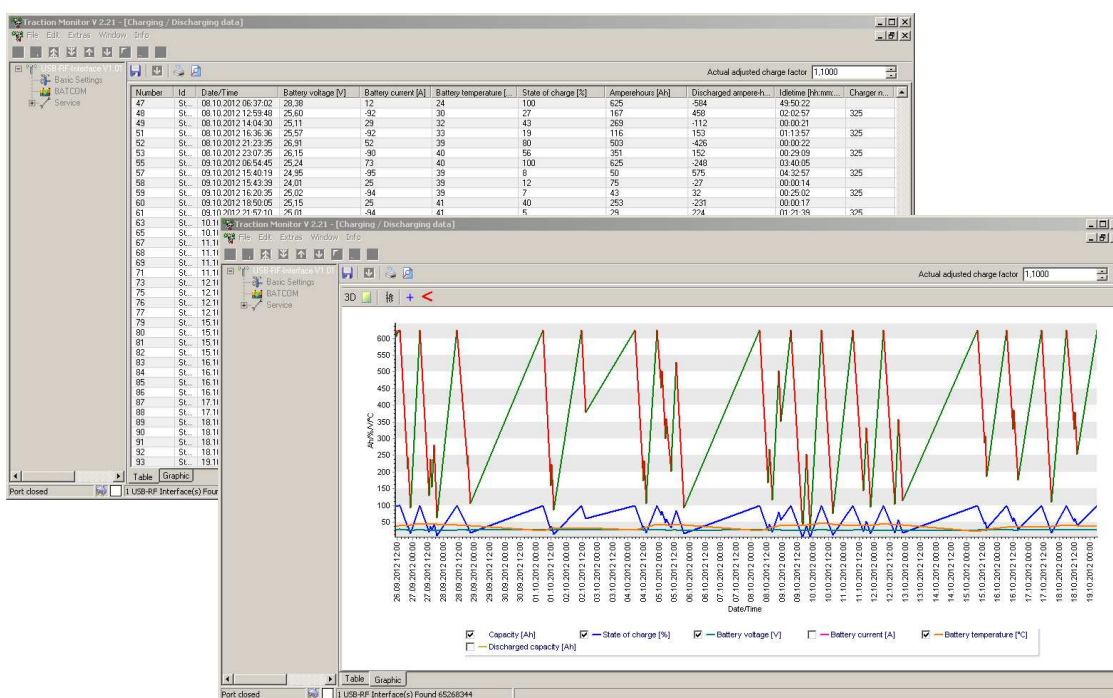

The currently specified charge factor that is used to determine the loaded capacities is displayed in the top right-hand part of this window. With controllers with a software version of <1.02, this value can be edited here. With controllers with a software of >= V1.02, this value is specified via the settings of the GNB PRO 6.2.3 and is displayed here (not editable).

All saved charge and discharge activities are shown in a table in the tabular view. The view can be switched to a graphical display using the "Graphic" changeover button. Various tools are displayed using the buttons , and it is possible to limit the range of time for which the view is displayed.

The respective view can be adapted at any time by selecting or deselecting individual values.

It is possible to save the data, export it in other formats or print it.

### 6.2.8 GNB PRO Save all data

In this window all data can be stored. After given the folder and the filename all data were read out and stored.

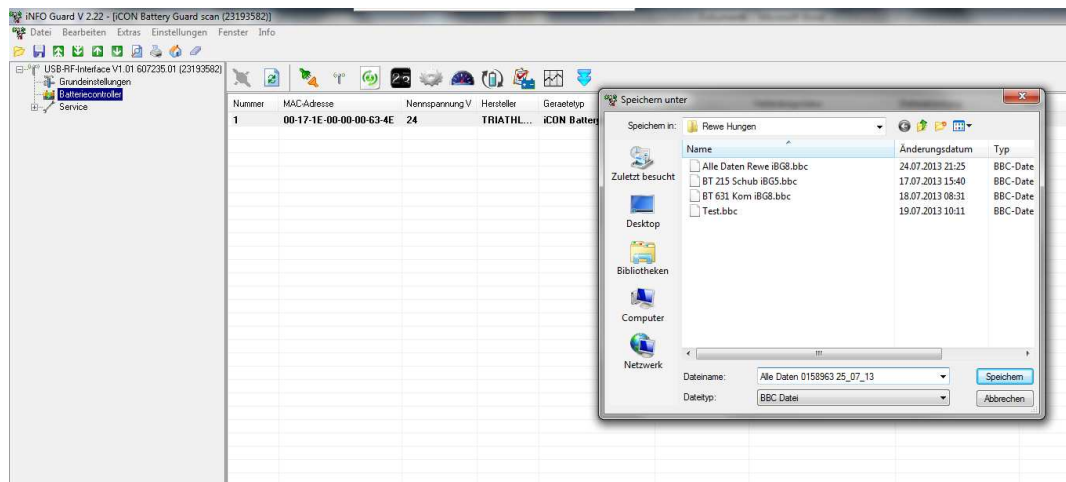

### 6.3 Faults and error messages

The state and faults of the GNB PRO are displayed via four light-emitting diodes. The following chapters provide an overview of the possible causes of faults and their respective remedies.

#### 6.3.1 Faults

| LED display                       | Possible cause   | Remedy   |
|-----------------------------------|--|--|
| No LED lights                     | Positive/negative connecting line defective<br><br>GNB PRO Electronics defective   | Check the connecting line for damage and have it replaced by a qualified electrician if necessary.<br><br>Inform service!  |
| All LEDs light or all LEDs flash! | GNB PRO not calibrated!  | The GNB PRO must be recalibrated!<br><b>Inform service!</b><br><b>Return the unit!</b>   |
| Fault LED lights                  | <i>Lights</i> if an error occurred when establishing a radio network.  | Disconnect the GNB PRO supply line and reconnect after approx. 10 seconds. If the error still exists, the GNB PRO must be recalibrated.<br><b>Inform service!</b><br><b>Return the unit!</b> |
| Fault LED lights                  | The temperature at the temperature sensor is greater than 100°C or the sensor lead is interrupted.<br><br>The temperature at the temperature sensor is smaller than -30°C or the sensor lead is short-circuited. | Replace the temperature sensor if necessary.<br><b>Inform service!</b><br><br>Replace the temperature sensor if necessary.<br><b>Inform service!</b>   |
| Over-temperature LED lights       | Battery temperature greater than 55°C  | Allow battery to cool down before it is used again until the LED is extinguished again (battery temperature smaller than 45°C)   |
| Electrolyte level LED lights      | Level of electrolyte in the cell too low.  | Refill distilled water.<br><b>Inform battery service!</b>  |

## 7 Maintenance



### **Dangerous electrical voltage warning!**

The GNB PRO is a piece of electrical equipment carrying voltages and currents which are dangerous to human beings.

For this reason, the GNB PRO must only be installed, opened and disassembled, if required, by qualified *electrical* personnel!

As a general rule, the mains supply and, if required, one battery contact must be interrupted before performing any actions and work on the GNB PRO.

### 7.1 Cleaning, inspection and maintenance

The GNB PRO is maintenance-free and allows normal operation if used properly.

- Dust or dirt on the GNB PRO can be removed with a dry cloth.



### **Caution!**

The GNB PRO housing complies with protection class IP 65 according to EN 60529 (protected against water jets). For this reason, direct cleaning with a high-pressure cleaner is not permitted, because otherwise there is the risk that the seal could become damaged, allowing water to get inside the unit!

Check at least once per month that

- the housing does not have any cracks or fissures and is closed properly,
- the insulation of the connection cable is undamaged,
- the battery pole connections are firmly tightened.

Eliminate any defects found without delay.

### 7.2 Replacement parts and accessories

Please contact the manufacturer or supplier quoting the unit data from the rating plate should you require replacement parts or accessories.

## 8 Disposal / environmental protection



Please return the unit to the designated return and collection points at the end of its service life.

Detailed information on this can be obtained from the waste management facilities or the responsible authorities.



### Caution!

Electronic scrap with its various plastic, metal and heavy metal components possesses a high hazard potential for the environment. For this reason, electronic scrap must be collected and disposed of separately from domestic and commercial waste.

Electronic scrap should be disposed of at the internal disposal department who will pass on the scrap to special companies (waste management facilities).

The packaging of the GNB PRO must be disposed of separately. Paper, cardboard and plastics must be recycled.

## Appendix

### Dimension and overview drawings

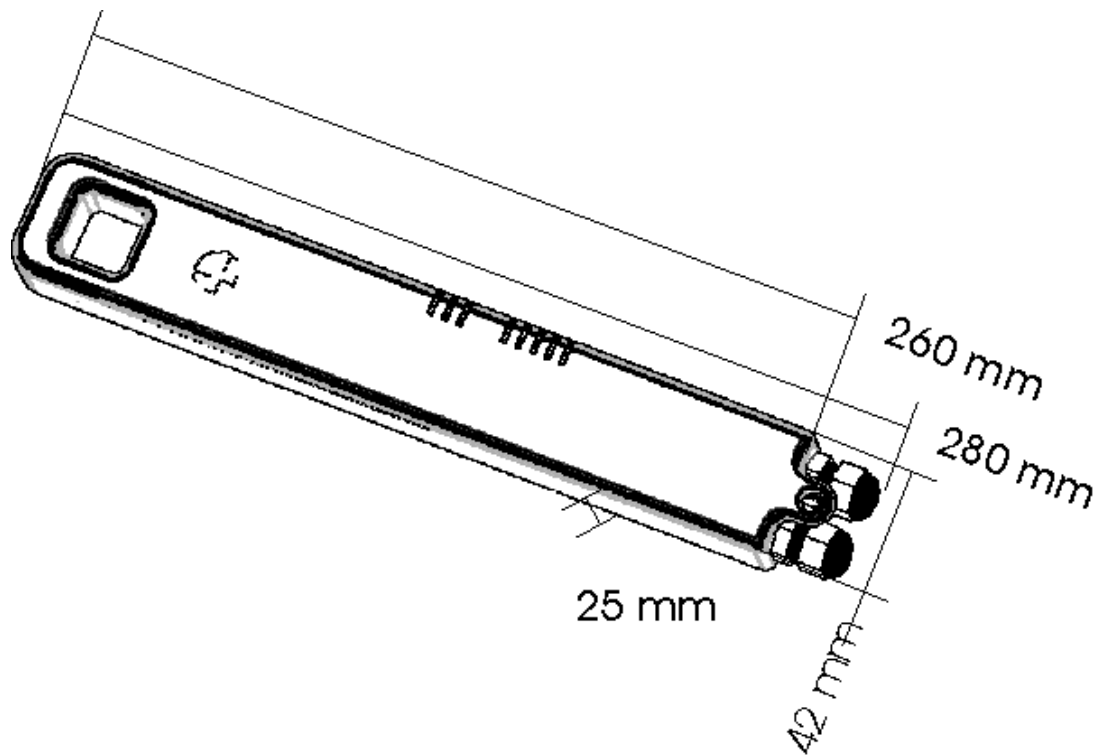



## List of symbols and abbreviations

All abbreviations used in these Instructions are listed below together with their meanings.

- A        Ampere
- Ah        Ampere hours
- BGV      Berufsgenossenschaftliche Vorschrift (compilation of all accident prevention rules issued by the German trade associations)
- i.e.      That is
- DIN      Deutsche Industrie Norm (German industrial standard)
- DC        direct current
- EMC      Electromagnetic compatibility
- EN        European Standard
- I        Current
- ISM      Industrial Scientific and Medical (describes the frequency range which is not subject to state regulation).
- IEC      International Electrotechnical Commission
- LED      Light emitting diode
- MAC      **M**edia **A**ccess **C**ontrol (hardware address of network components, within a radio network, which is used to uniquely identify the units in the network)
- max.     maximal
- t        time
- PN        Part number
- U        Voltage
- etc.     and so on
- V        Volt
- ZVEI     Central Association of German Electrical and Electronics Industry.

---

| <b>Technical data</b>      | <b>General information</b>  |
|----------------------------|---|
| <b>Series</b>              | <b>GNB PRO</b>  |
| <b>Unit no.</b>            | See type plate  |
| <b>Part no.</b>            | 121340  |
| <b>Connection voltage</b>  | 18 – 120 V DC   |
| <b>Current consumption</b> | max. 60 mA at 18 V DC   |
| <b>Temperature range</b>   | -10 to 60 °C  |
| <b>Protection class</b>    | IP 65 according to EN 60529   |
| <b>Housing</b>             | PC-GF10 plastic housing.<br>Acid-resistant against diluted sulphuric acid with an acid density of up to 1.4 kg/l.<br>Dimensions (LxHxW): 200 x 25 x 42 mm |
| <b>Standards</b>           | 73/23/EEC – Low-Voltage Directive<br>89/336/EEC – EMC-Directive<br>Shock and vibration tested according to IEC 68-2-29 & IEC 68-2-6                       |