

Product overview

Batteries for Cars

Excell EB357



Part number	EB357
Technology	Flooded
EAN/GTIN	3661024034340
Voltage	12 V
Capacity	35.0 Ah
CCA	240 A
Length	187 mm
Width	127 mm
Height	220 mm
Box size	B19
Polarity	ETN 1
Terminal Type	JIS taper post
Hold Down	B0
Weights (subject of variation)	8.90 kg

Polarity



Terminal Type

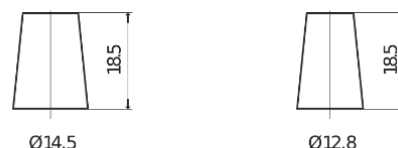

Positive Terminal

Negative Terminal

Hold Down



Design, features and specifications are subject to change without notice. We disclaim any representation or warranty, express or implied, concerning the data or recommendations, and in no event shall be liable for any loss or damage claimed to have arisen as a result. Some products may not be available in your local market.