

Product overview



Batteries for Trucks, Buses, Construction, Agriculture

Endurance+PRO Gel FD851T



Part number	FD851T
Technology	GEL
EAN/GTIN	3661024047388
Voltage	12 V
Capacity	85 Ah
CCA	350 A
Length	349 mm
Width	175 mm
Height	235 mm
Box size	D02
Polarity	ETN 1
Terminal Type	EN taper post
Hold Down	B0
Weights (subject of variation)	29.50 kg

Polarity

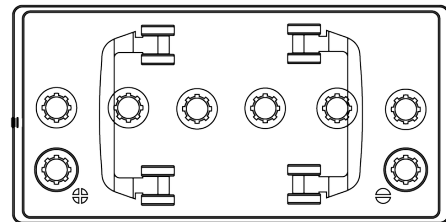

Terminal Type



Positive Terminal



Negative Terminal

Hold Down



Design, features and specifications are subject to change without notice. We disclaim any representation or warranty, express or implied, concerning the data or recommendations, and in no event shall be liable for any loss or damage claimed to have arisen as a result. Some products may not be available in your local market.