

Product overview

Batteries for Motorcycles, ATVs, Snowmobiles, Garden

AGM MC (Dry) ETZ10-BS



Part number	ETZ10-BS
Technology	AGM
EAN/GTIN	3661024033824
Voltage	12 V
Capacity	9 Ah
CCA	145 A
Length	150 mm
Width	90 mm
Height	95 mm
Box size	C53
Polarity	ETN 1
Terminal Type	M12
Hold Down	B0
Weights (subject of variation)	3.40 kg

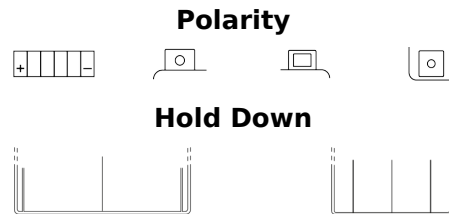

Design, features and specifications are subject to change without notice. We disclaim any representation or warranty, express or implied, concerning the data or recommendations, and in no event shall be liable for any loss or damage claimed to have arisen as a result. Some products may not be available in your local market.