

Product overview

Batteries for Motorcycles, ATVs, Snowmobiles, Garden

Conventional E60-N24L-A



Part number	E60-N24L-A
Technology	Flooded
EAN/GTIN	3661024033589
Voltage	12 V
Capacity	28.0 Ah
CCA	280 A
Length	185 mm
Width	125 mm
Height	175 mm
Box size	C67
Polarity	ETN 0
Terminal Type	M11
Hold Down	B0
Weights (subject of variation)	8.60 kg

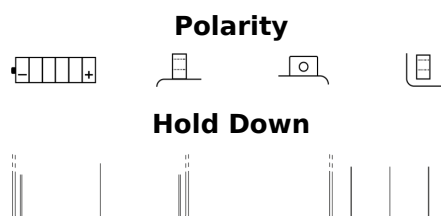

Design, features and specifications are subject to change without notice. We disclaim any representation or warranty, express or implied, concerning the data or recommendations, and in no event shall be liable for any loss or damage claimed to have arisen as a result. Some products may not be available in your local market.