

**Product overview**

Batteries for Marine and Leisure

**Equipment GEL ES1350**



|                                |               |
|--------------------------------|---------------|
| Part number                    | ES1350        |
| Technology                     | GEL           |
| EAN/GTIN                       | 3661024035774 |
| Voltage                        | 12 V          |
| Capacity                       | 120.0 Ah      |
| Watt hour                      | 1350 Wh       |
| Length                         | 513 mm        |
| Width                          | 189 mm        |
| Height                         | 223 mm        |
| Box size                       | D04           |
| Polarity                       | ETN 3         |
| Terminal Type                  | EN taper post |
| Hold Down                      | B0            |
| Weights (subject of variation) | 40.00 kg      |

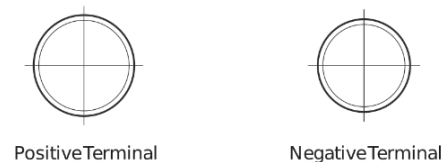
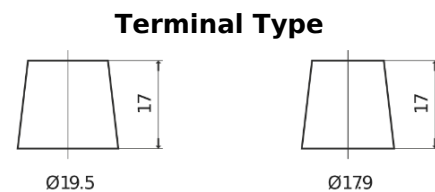
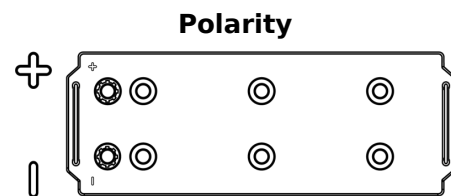

Design, features and specifications are subject to change without notice. We disclaim any representation or warranty, express or implied, concerning the data or recommendations, and in no event shall be liable for any loss or damage claimed to have arisen as a result. Some products may not be available in your local market.