

Product overview

Batteries for Trucks, Buses, Construction, Agriculture

StartPRO DG1806



Part number	DG1806
Technology	Flooded
EAN/GTIN	3661024025508
Voltage	12 V
Capacity	180.0 Ah
CCA	1000 A
Length	510 mm
Width	218 mm
Height	225 mm
Box size	D09
Polarity	ETN 4
Terminal Type	EN taper post
Hold Down	B3
Weights (subject of variation)	43.00 kg

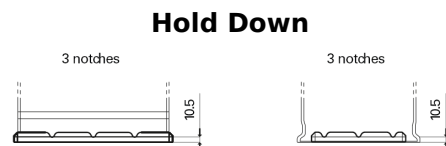
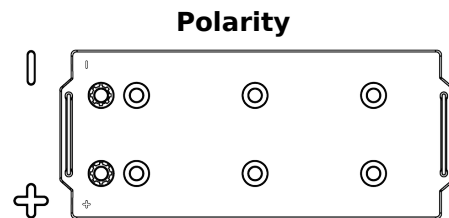

Design, features and specifications are subject to change without notice. We disclaim any representation or warranty, express or implied, concerning the data or recommendations, and in no event shall be liable for any loss or damage claimed to have arisen as a result. Some products may not be available in your local market.